

THESE DRAWINGS ARE THE PROPERTY OF QUALTEK ELECTRONICS AND NOT TO BE REPRODUCED FOR OR COMMUNICATED TO A THIRD PARTY WITHOUT THE EXPRESS WRITTEN PERMISSION OF AN OFFICER OF QUALTEK ELECTRONICS.

REVISION			
REV.	DESCRIPTION	DATE	APPROVED
B	RoHS Compliancy	06-01-06	DP

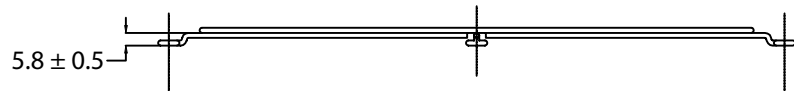
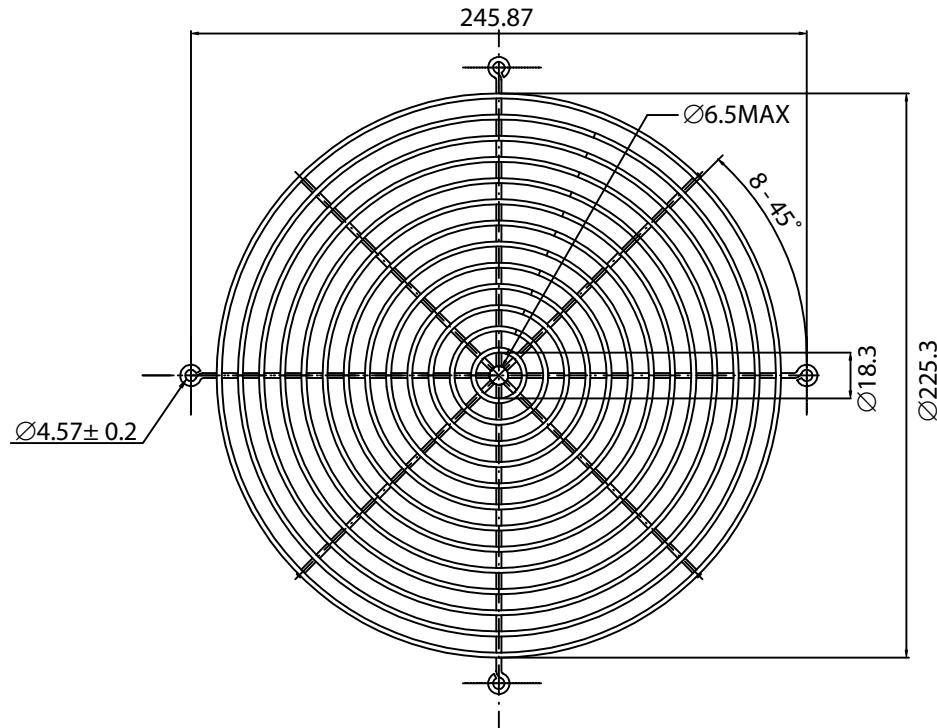

NOTES:

1. MATERIAL: C1008 BRIGHT BASIC WIRE
2. FINISH: BRIGHT NICKEL CHROME PLATING
3. 0.35 ± 0.05 DEPTH OF SERRATIONS ON WIRE
4. RING: $\varnothing 2.0 \pm 0.1\text{mm}$
RIB: $\varnothing 2.0 \pm 0.1\text{mm}$
5. GENERAL TOLERANCE UNLESS NOTED IS $\pm 0.8\text{mm}$
6. RoHS COMPLIANT

CONTROLLED

Dim range (mm)	Tolerance +/- (mm)	Qualtek Electronics Corp. FAN-S DIVISION		
		Part Number:	RoHS Compliant	
0-5	0.1	08155	Description: WIRE FORM FAN GUARD (254mm)	
5-16	0.15		UNIT: mm	REV: B
16-64	0.2		Checked / Date	Approved / Date
64-250	0.4	Drawn / Date		
250-1000	0.5	B. ZHANG 12-06-04	12-06-04	JJH / 12-06-04
1000-1500	1.0			

Mouser Electronics

Authorized Distributor

Click to View Pricing, Inventory, Delivery & Lifecycle Information:

[Qualtek:](#)

[08155](#)