

# STS232050UL40

## TVS Diode array ESD suppressor

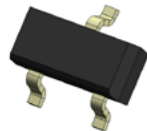

### Product features

- 60 watts peak pulse power per line ( $t_p=8/20 \mu s$ )
- Protects two I/O lines with uni-directional
- Low clamping voltage
- Ultra-low capacitance:  $C_J=0.4 \text{ pF}$  typical
- Working voltage: 5 V
- Low leakage current
- Meets moisture sensitivity level (MSL) 3
- Molding compound flammability rating: UL 94V-0
- Termination finish: Tin

### Applications

- USB 2.0 and USB 3.0
- HDMI 1.3 and HDMI 1.4
- SATA and eSATA
- DVI PCI Express
- Portable Electronics
- IEEE 1394

### Environmental compliance and general specifications

- IEC61000-4-2 (ESD)
  - $\pm 20 \text{ kV}$  (air)
  - $\pm 20 \text{ kV}$  (contact)
- IEC61000-4-5 (Lightning) 4 A (8/20  $\mu s$ )



### Ordering part number

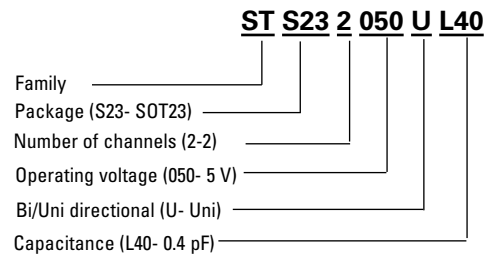

### Pin out/functional diagram

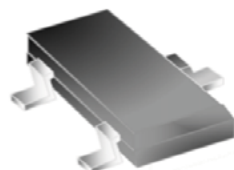

SOT-23

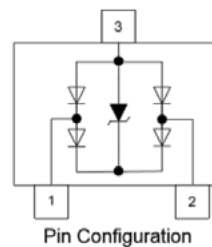

### Absolute maximum ratings

(+25 °C, RH=45%-75%, unless otherwise noted)

#### STS232050UL40

Parameter	Symbol	Value	Unit
Peak pulse power dissipation on 8/20 $\mu$ s waveform	$P_{PP}$	60	W
ESD per IEC 61000-4-2 (Air)	$V_{ESD}$	+/-20	kV
ESD per IEC 61000-4-2 (Contact)		+/-20	
Lead soldering temperature	$T_L$	+260 (10 seconds)	°C
Operating junction temperature range	$T_J$	-55 to +125	°C
Storage temperature range	$T_{STG}$	-55 to +150	°C

### Electrical characteristics

(+25 °C)

#### STS232050UL40

Parameter	Test condition	Minimum	Typical	Maximum	Symbol (Units)
Reverse working voltage	-	-	-	5.0	$V_{RWM}$ (V)
Reverse breakdown voltage	$I_r = 1$ mA	7.0	8.0	9.0	$V_{BR}$ (V)
Reverse leakage current	$V_{RWM} = 5$ V	-	-	100	$I_R$ ( $\mu$ A)
Clamping voltage	$I_{PP} = 1$ A, $t_p = 8/20$ $\mu$ s	-	-	11	$V_C$ (V)
	$I_{PP} = 4$ A, $t_p = 8/20$ $\mu$ s	-	-	15	$V_C$ (V)
Junction capacitance	$V_{RWM} = 0$ V, $f = 1$ MHz Any I/O pin to GND	-	0.4	0.65	$C_J$ (pF)
	$V_{RWM} = 0$ V, $f = 1$ MHz Between any I/O pin	-	0.25	0.40	$C_J$ (pF)

### Mechanical parameters, pad layout- mm/inches

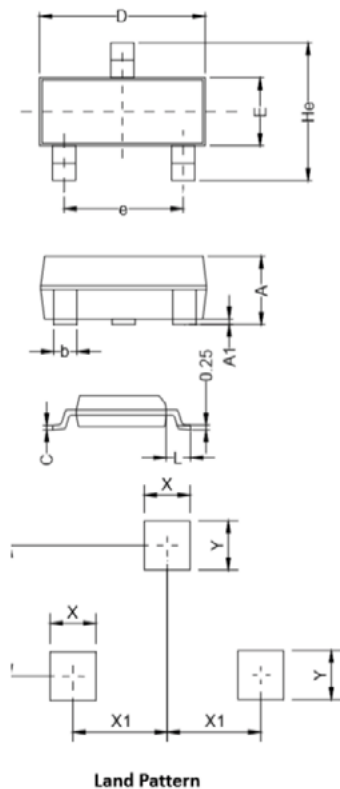

Dimension	Millimeters		Inches	
	Minimum	Maximum	Minimum	Maximum
A	0.90	1.15	0.035	0.045
A1	0.00	0.10	0.000	0.004
b	0.25	0.325	0.010	0.013
C	0.22	0.25	0.009	0.010
D	2.80	3.00	0.110	0.118
e	1.80	1.90	0.071	0.075
E	1.20	1.40	0.047	0.055
L	0.30	0.50	0.012	0.020
He	2.25	2.55	0.089	0.100
X	0.80		0.031	
X1	0.95		0.037	
Y	0.80		0.031	
Z	2.02		0.080	

### Part marking

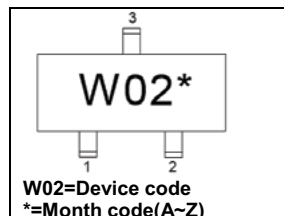

**Packaging information mm/inches**

Drawing not to scale.

Supplied in tape and reel packaging, 3,000 parts per 7" diameter reel (EIA-481 compliant)

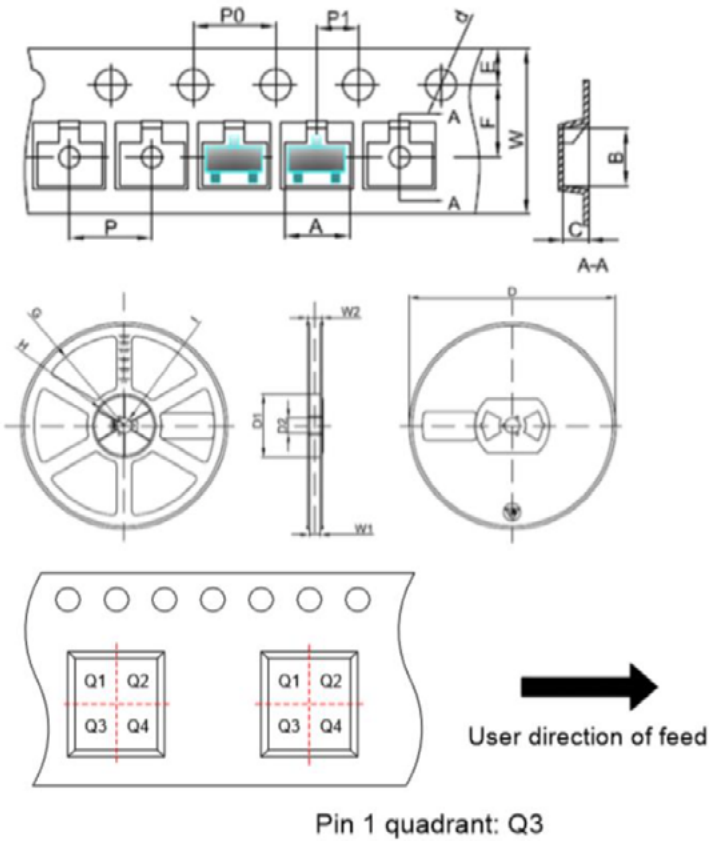

Symbol	Millimeters	Inches
	Typ.	Typ.
A	3.15	0.124
B	2.77	0.109
C	1.22	0.048
d	Φ1.50	Φ0.059
E	1.75	0.069
F	3.50	0.138
P0	4.00	0.157
P	4.00	0.157
P1	2.00	0.079
W	8.00	0.315
D	Φ178	Φ7.008
D1	54.40	2.142
D2	13.00	0.512
G	R78.00	R3.071
H	R25.60	R1.008
I	R6.50	R0.256
W1	9.50	0.374
W2	12.30	0.484

**Ratings and V-I characteristic curves** (+25 °C unless otherwise noted)

**V- I curve characteristics (Uni-directional)**

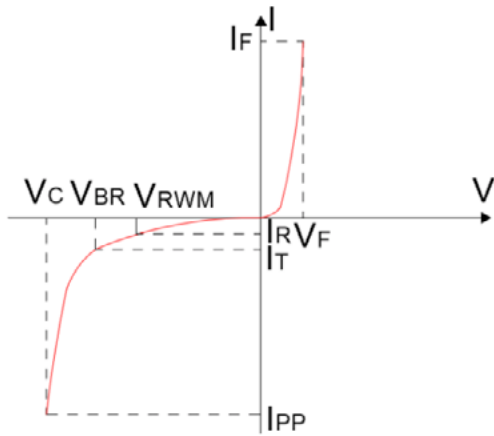

**Pulse waveform (8/20  $\mu$ s)**

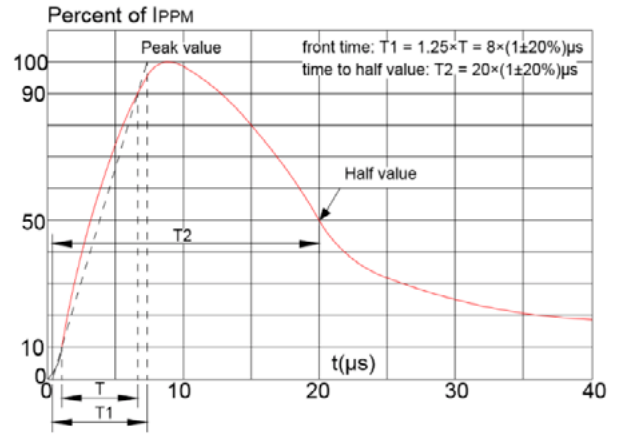

**Pulse derating curve**

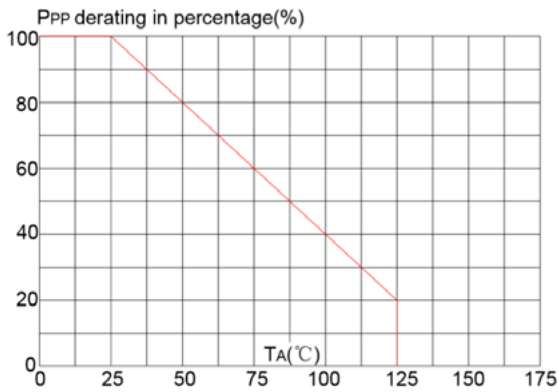

**ESD waveform**

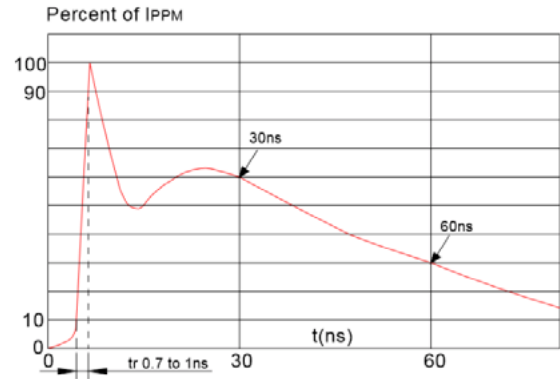

**Solder reflow profile**

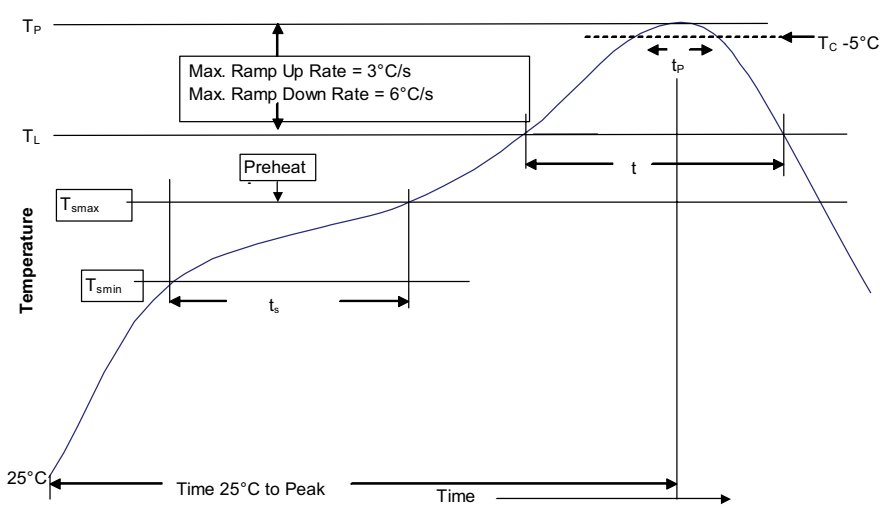

**Table 1 - Standard SnPb solder (T<sub>C</sub>)**

Package thickness	Volume mm <sup>3</sup> <350	Volume mm <sup>3</sup> ≥350
<2.5 mm	235 °C	220 °C
≥2.5 mm	220 °C	220 °C

**Table 2 - Lead (Pb) free solder (T<sub>C</sub>)**

Package thickness	Volume mm <sup>3</sup> <350	Volume mm <sup>3</sup> 350 - 2000	Volume mm <sup>3</sup> >2000
<1.6 mm	260 °C	260 °C	260 °C
1.6 – 2.5 mm	260 °C	250 °C	245 °C
>2.5 mm	250 °C	245 °C	245 °C

**Reference J-STD-020**

Profile feature	Standard SnPb solder	Lead (Pb) free solder
Preheat and soak		
• Temperature min. (T <sub>smin</sub> )	100 °C	150 °C
• Temperature max. (T <sub>smax</sub> )	150 °C	200 °C
• Time (T <sub>smin</sub> to T <sub>smax</sub> ) (t <sub>s</sub> )	60-120 seconds	60-120 seconds
Ramp up rate T <sub>L</sub> to T <sub>p</sub>	3 °C/ second max.	3 °C/ second max.
Liquidous temperature (T <sub>L</sub> )	183 °C	217 °C
Time (t <sub>L</sub> ) maintained above T <sub>L</sub>	60-150 seconds	60-150 seconds
Peak package body temperature (T <sub>p</sub> )*	Table 1	Table 2
Time (t <sub>p</sub> )* within 5 °C of the specified classification temperature (T <sub>C</sub> )	20 seconds*	30 seconds*
Ramp-down rate (T <sub>p</sub> to T <sub>L</sub> )	6 °C/ second max.	6 °C/ second max.
Time 25 °C to peak temperature	6 minutes max.	8 minutes max.

\* Tolerance for peak profile temperature (T<sub>p</sub>) is defined as a supplier minimum and a user maximum.

Life Support Policy: Eaton does not authorize the use of any of its products for use in life support devices or systems without the express written approval of an officer of the Company. Life support systems are devices which support or sustain life, and whose failure to perform, when properly used in accordance with instructions for use provided in the labeling, can be reasonably expected to result in significant injury to the user.

Eaton reserves the right, without notice, to change design or construction of any products and to discontinue or limit distribution of any products. Eaton also reserves the right to change or update, without notice, any technical information contained in this bulletin.

**Eaton**  
Electronics Division  
1000 Eaton Boulevard  
Cleveland, OH 44122  
United States  
Eaton.com/electronics

© 2020 Eaton  
All Rights Reserved  
Printed in USA  
Publication No. 11155 BU-MC20137  
September 2020

Eaton is a registered trademark.  
All other trademarks are property of their respective owners.

Follow us on social media to get the latest product and support information.



# Mouser Electronics

Authorized Distributor

Click to View Pricing, Inventory, Delivery & Lifecycle Information:

[Eaton:](#)

[STS232050UL40](#)